

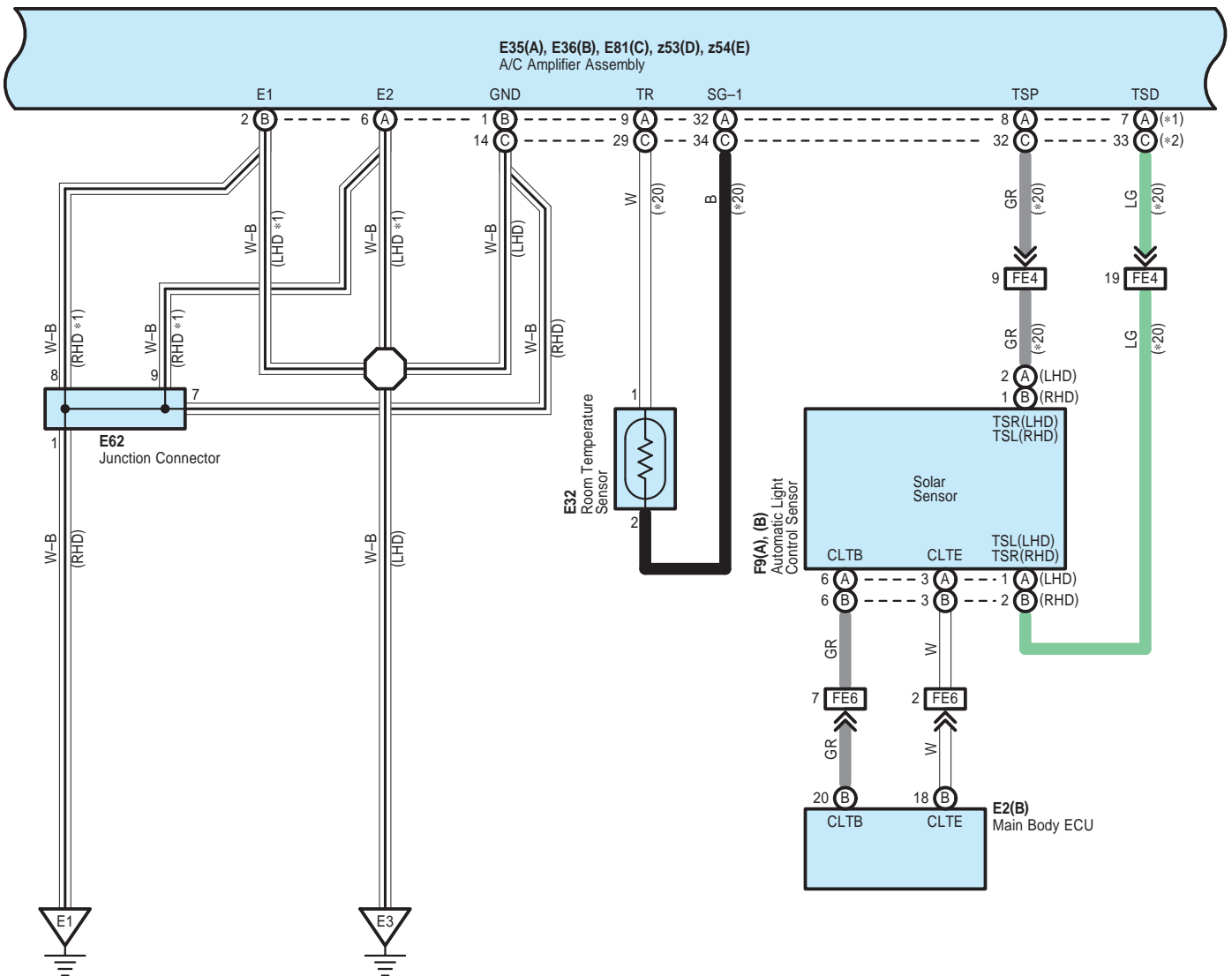

- * 1 : w/ Rear A/C
- * 2 : w/o Rear A/C
- * 4 : Gasoline
- * 5 : Diesel
- *10 : w/ Rear Cooler
- *19 : From Jan. 2012 Production Liftgate Type, Swing Type
- *20 : Automatic Air Conditioner
- *23 : w/ Condenser Fan
- *24 : w/ Cool Box
- *25 : w/ Front Window Deicer

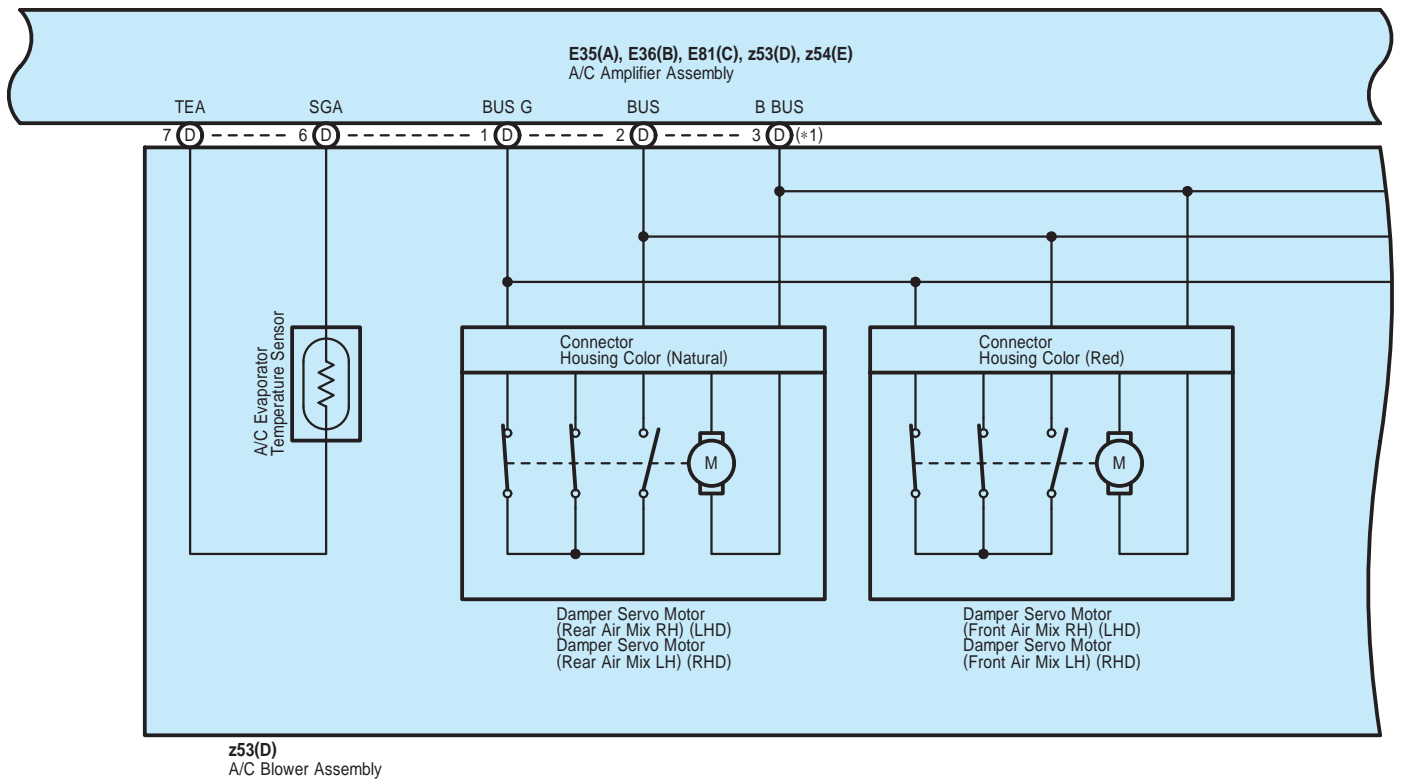



G
(*19)

G
(*19)

- * 1 : w/ Rear A/C
- *19 : From Jan. 2012 Production Liftgate Type, Swing Type

E35(A), E36(B), E81(C), z53(D), z54(E)
A/C Amplifier Assembly

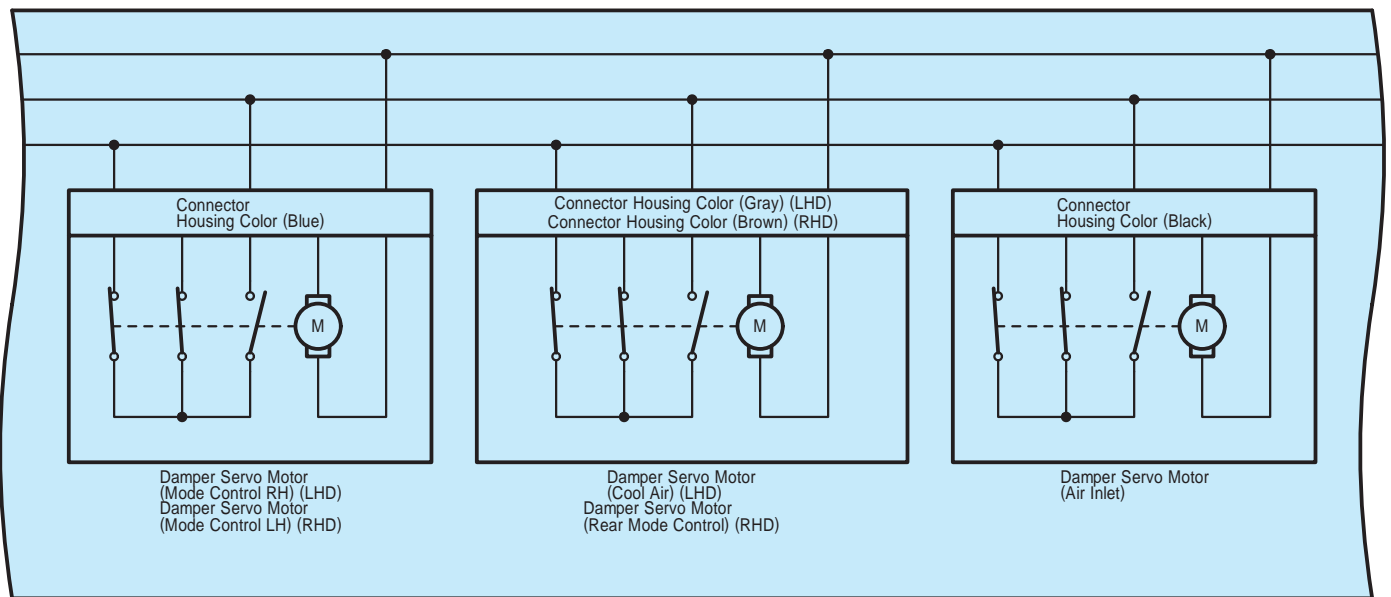

z53(D)
A/C Blower Assembly



E35(A), E36(B), E81(C), z53(D), z54(E)
A/C Amplifier Assembly

BUS G 8 (D) --- BUS 9 (D) --- B BUS 10 (D) (*1)

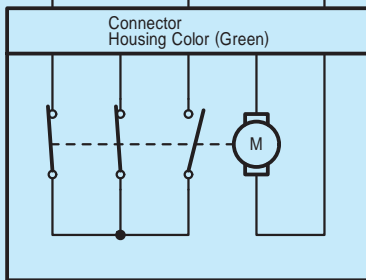

Damper Servo Motor
(Mode Def Control) (RHD)

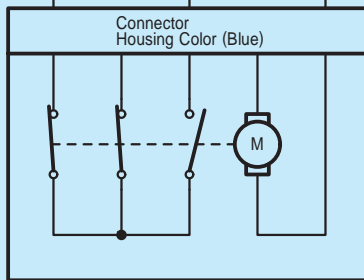

Damper Servo Motor
(Mode Control LH) (LHD)
Damper Servo Motor
(Mode Control RH) (RHD)

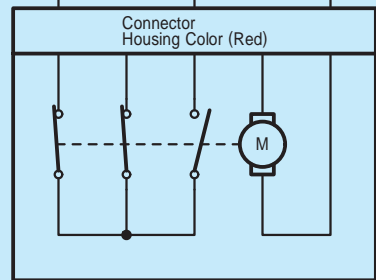

Damper Servo Motor
(Front Air Mix LH) (LHD)
Damper Servo Motor
(Front Air Mix RH) (RHD)

z53(D)
A/C Blower Assembly

G
(*19)

G
(*19)

* 1 : w/ Rear A/C
 *19 : From Jan. 2012 Production Liftgate Type, Swing Type

E35(A), E36(B), E81(C), z53(D), z54(E)
 A/C Amplifier Assembly

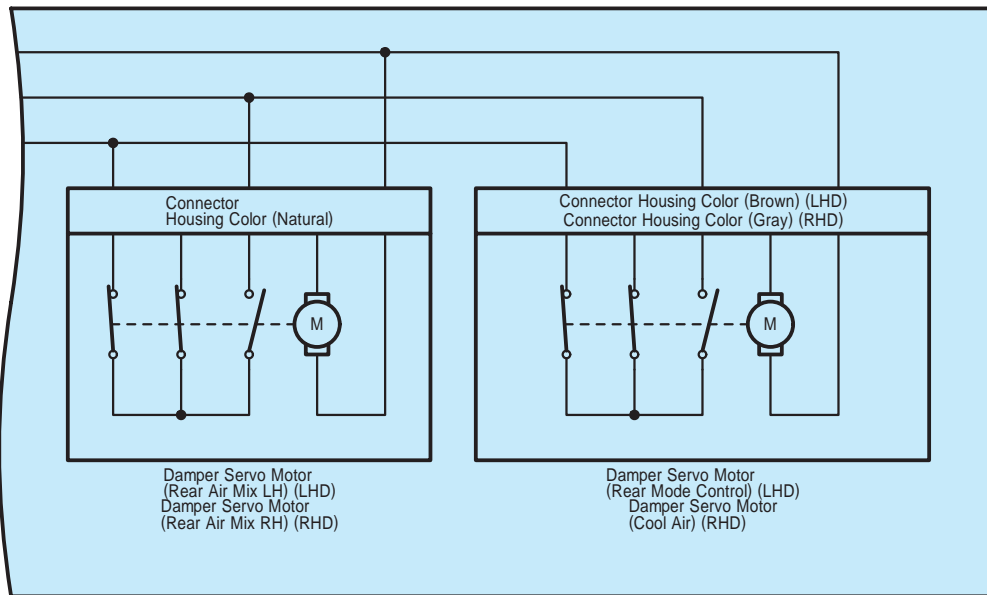

z53(D)
 A/C Blower Assembly

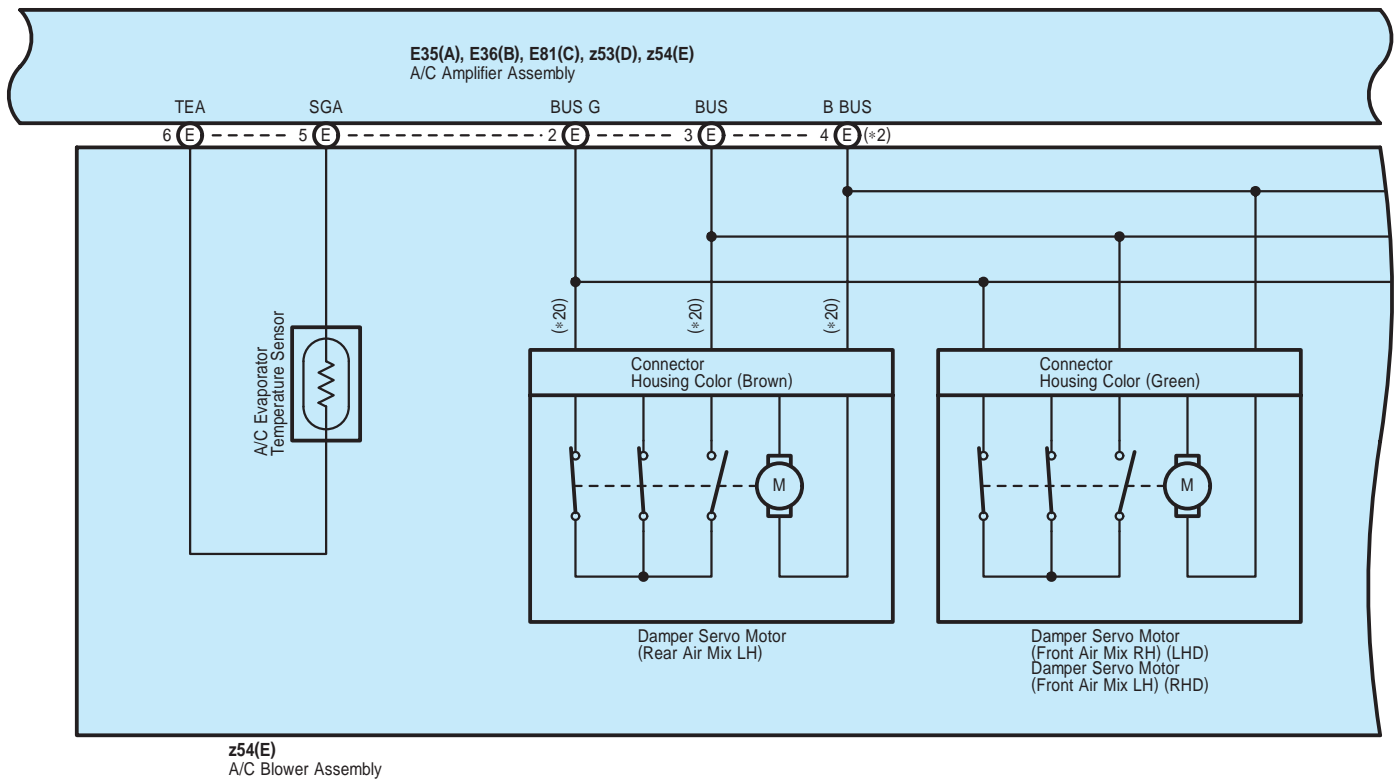

G
(*19)

G
(*19)

- * 2 : w/o Rear A/C
- *19 : From Jan. 2012 Production Liftgate Type, Swing Type
- *20 : Automatic Air Conditioner

E35(A), E36(B), E81(C), z53(D), z54(E)
A/C Amplifier Assembly

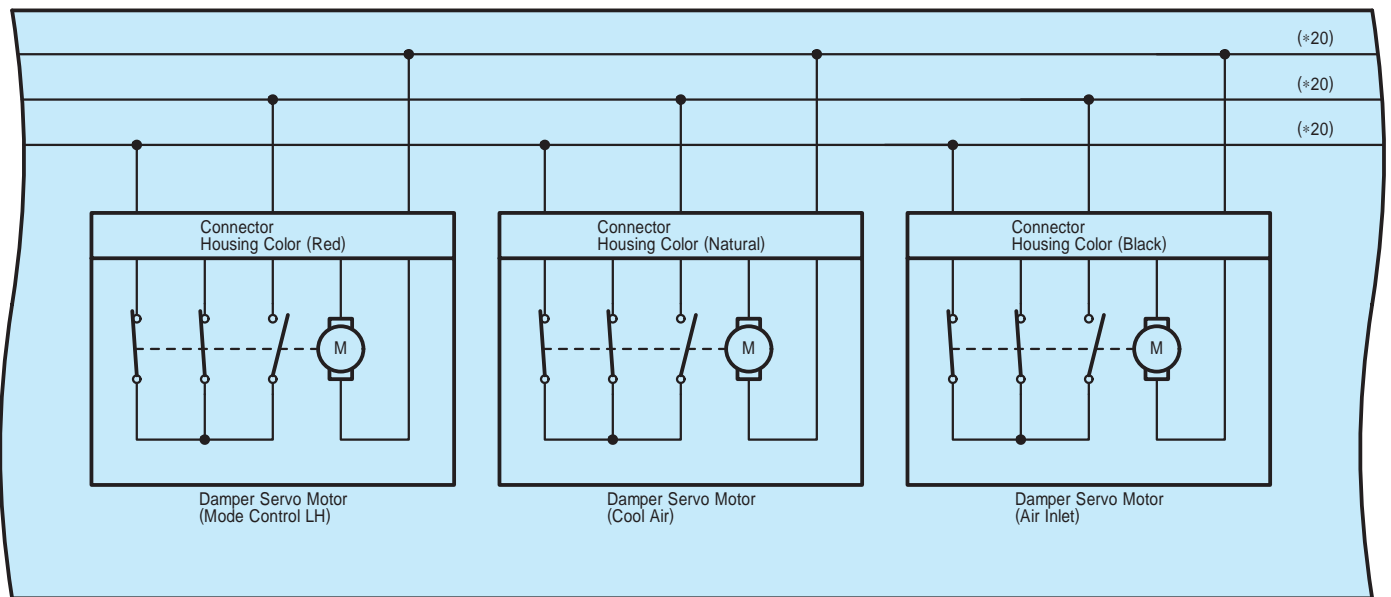

z54(E)
A/C Blower Assembly



E35(A), E36(B), E81(C), z53(D), z54(E)
A/C Amplifier Assembly

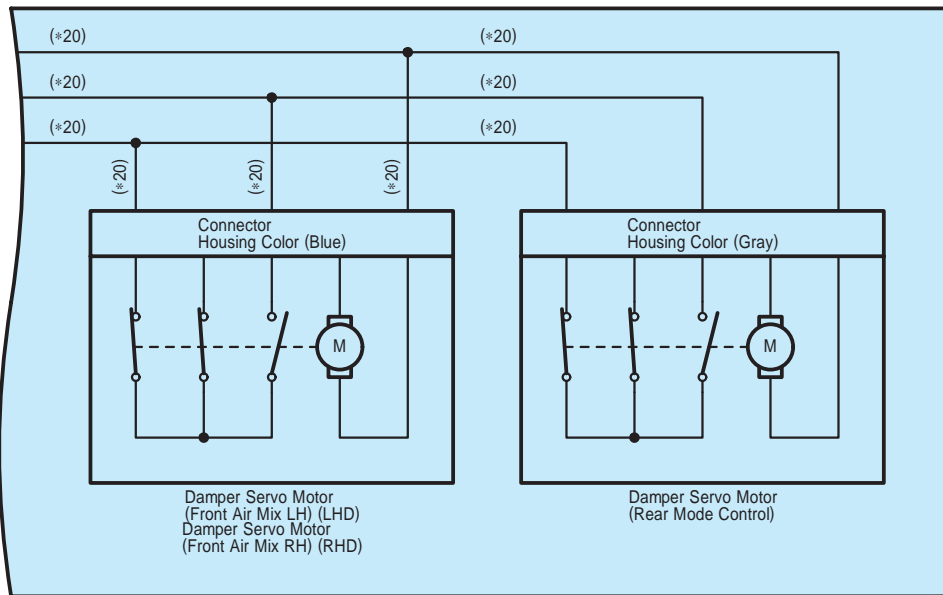

z54(E)
A/C Blower Assembly



- * 1 : w/ Rear A/C
- *19 : From Jan. 2012 Production Liftgate Type, Swing Type
- *20 : Automatic Air Conditioner

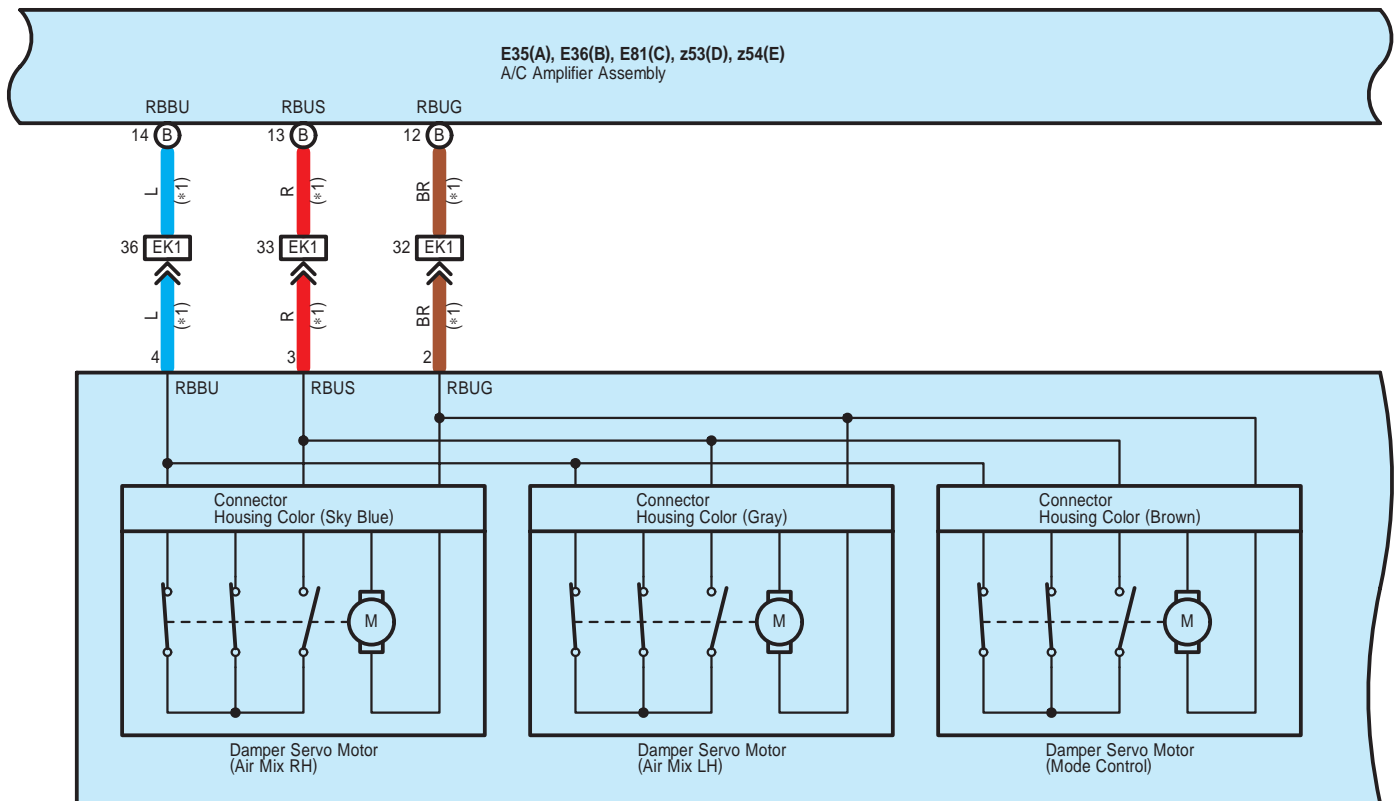

K19
Rear A/C Blower Assembly

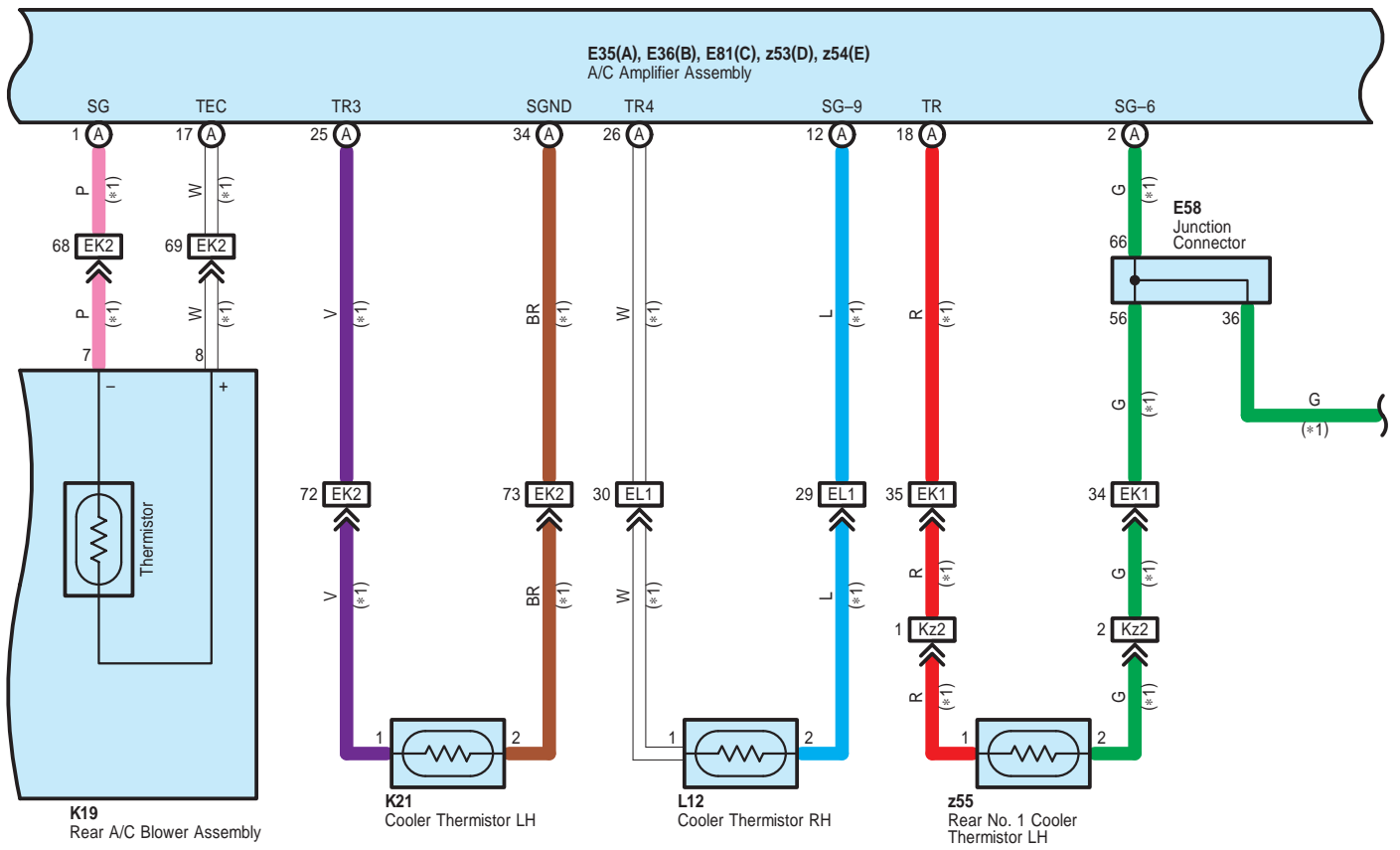

- * 1 : w/ Rear A/C
- * 2 : w/o Rear A/C
- * 3 : w/ Viscous Heater
- * 18 : Before Jan. 2012 Production Liftgate Type
- * 19 : From Jan. 2012 Production Liftgate Type, Swing Type

- * 22 : w/ Viscous Heater 1VD-FTV w/o DPF
- * 27 : Before Jan. 2012 Production
- * 28 : From Jan. 2012 Production
- * 32 : w/o Navigation System
- * 33 : w/ Viscous Heater 1VD-FTV w/ DPF

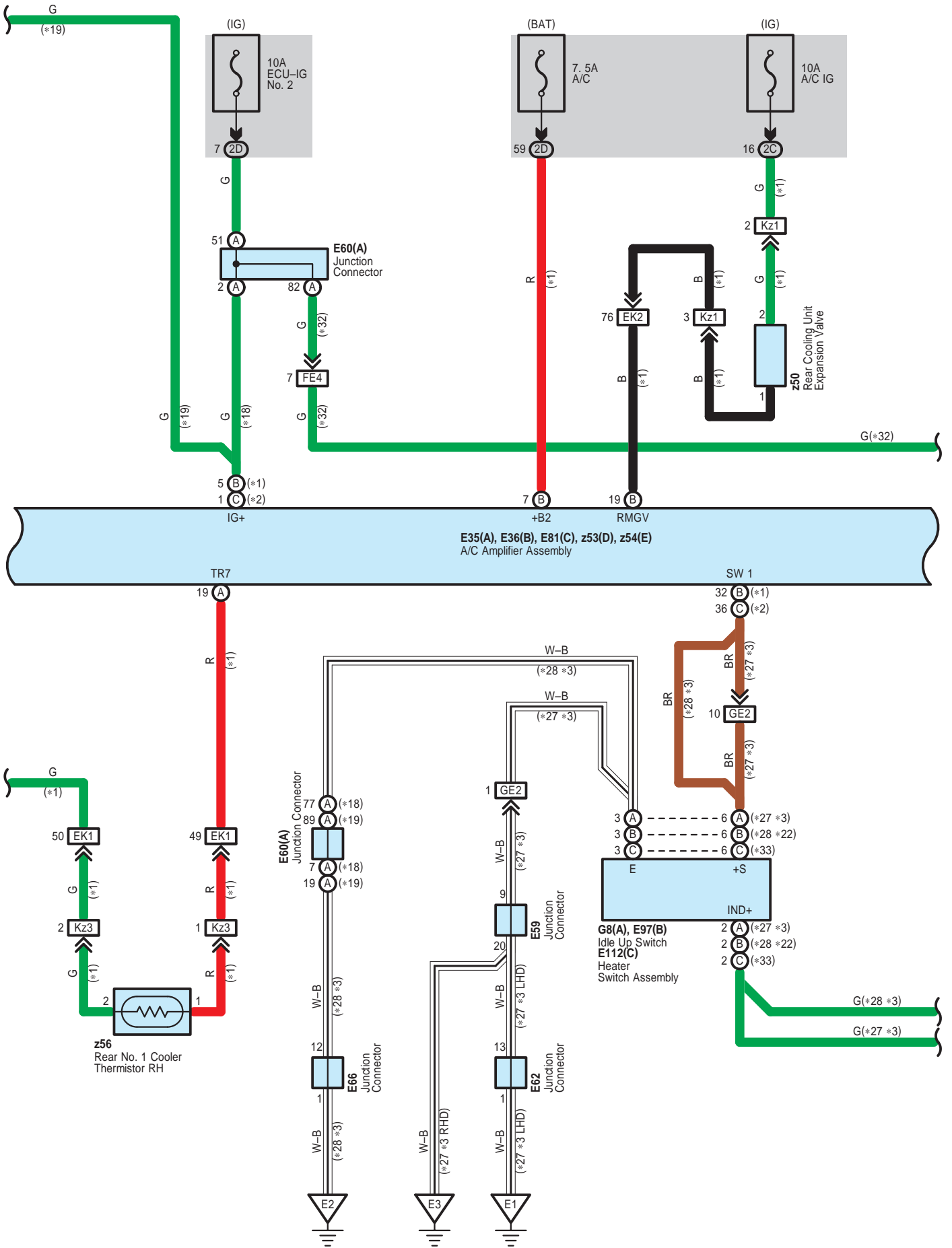

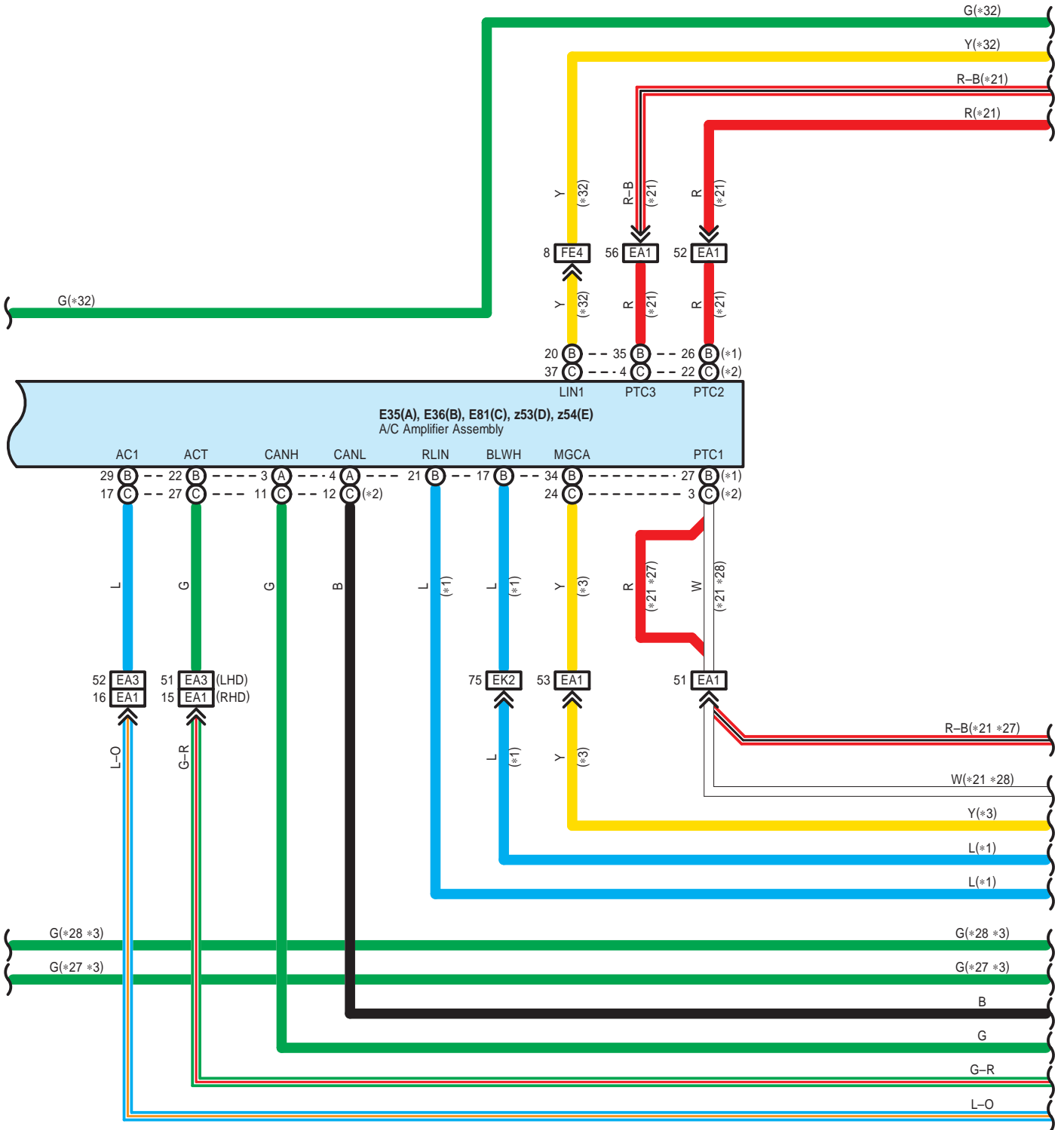

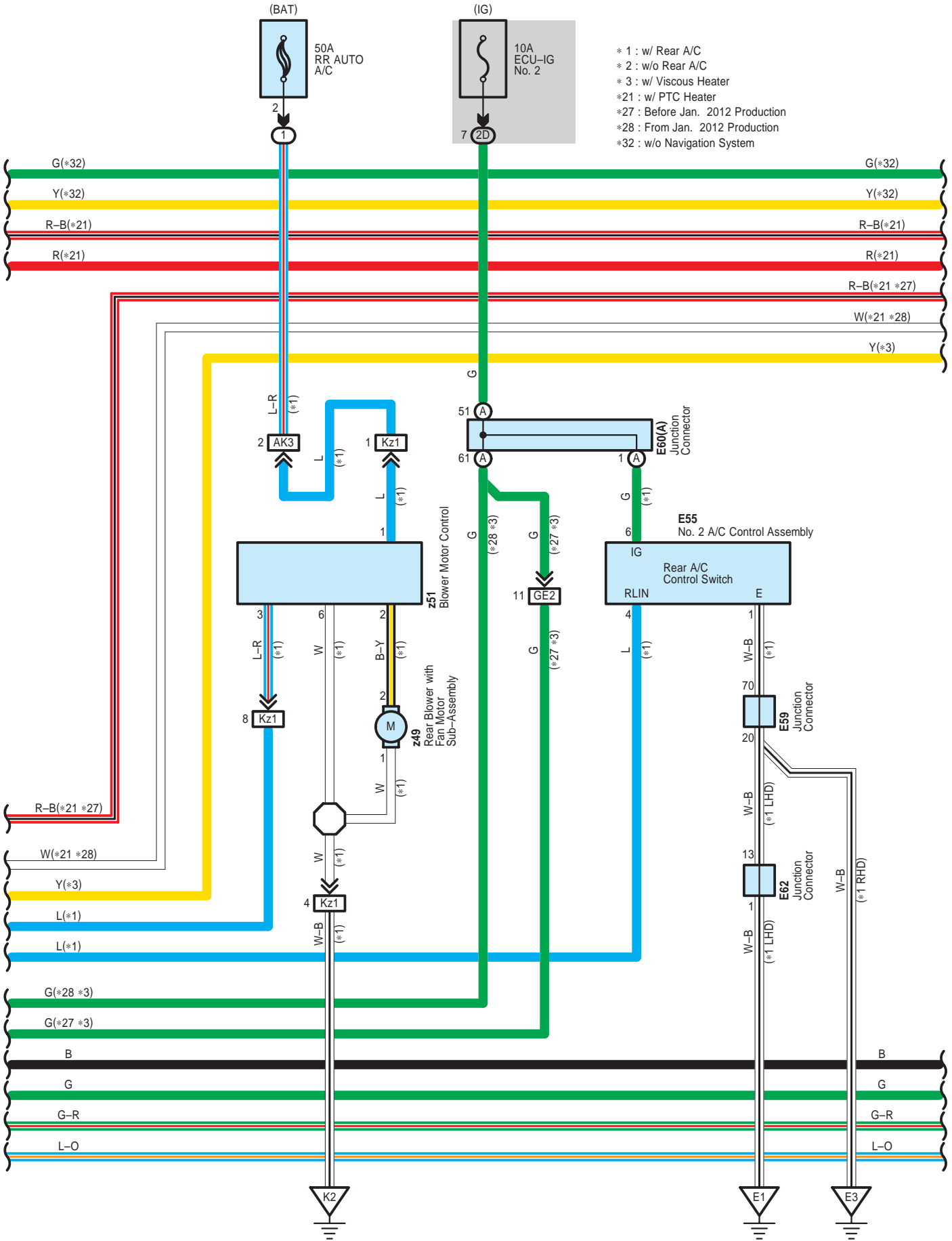

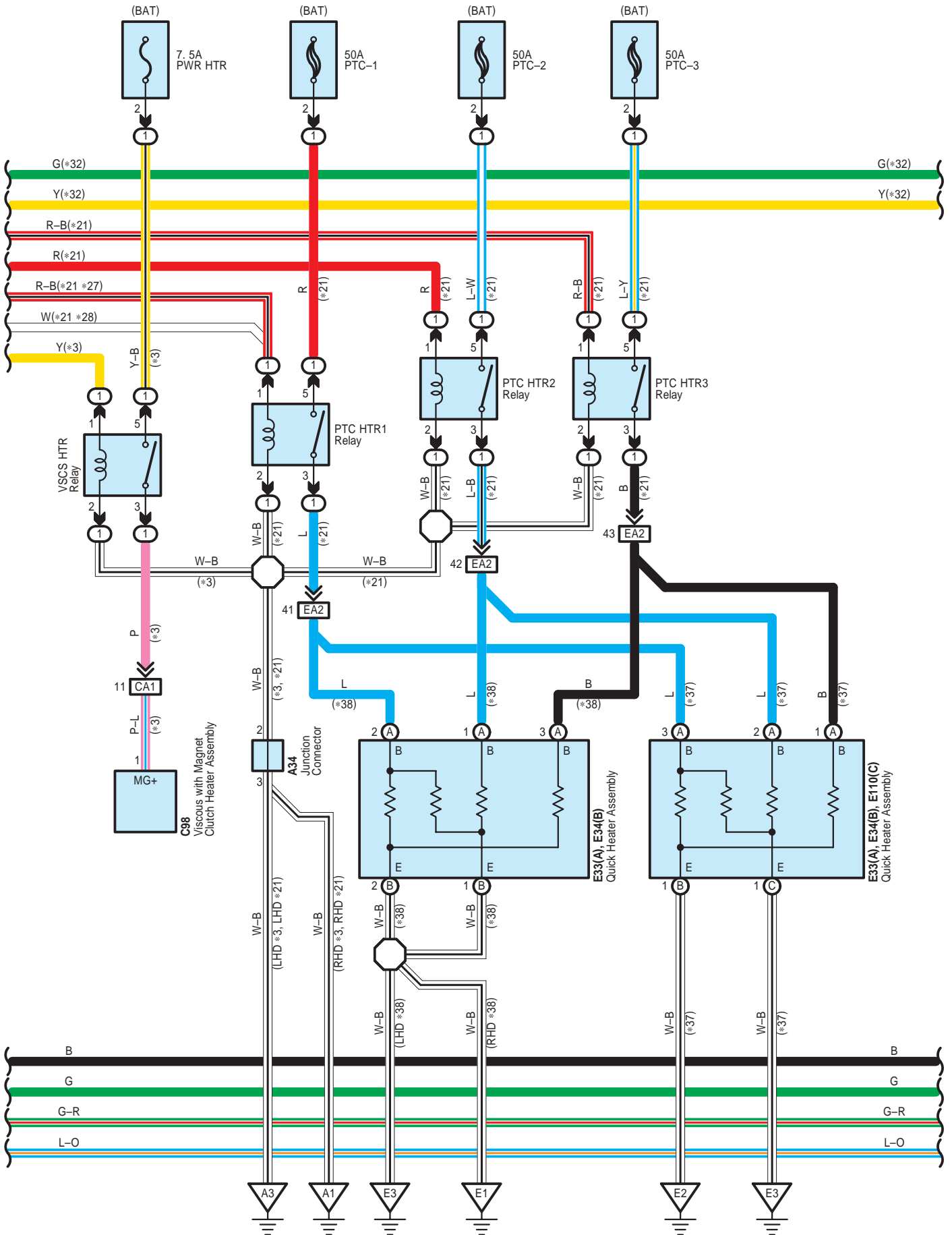

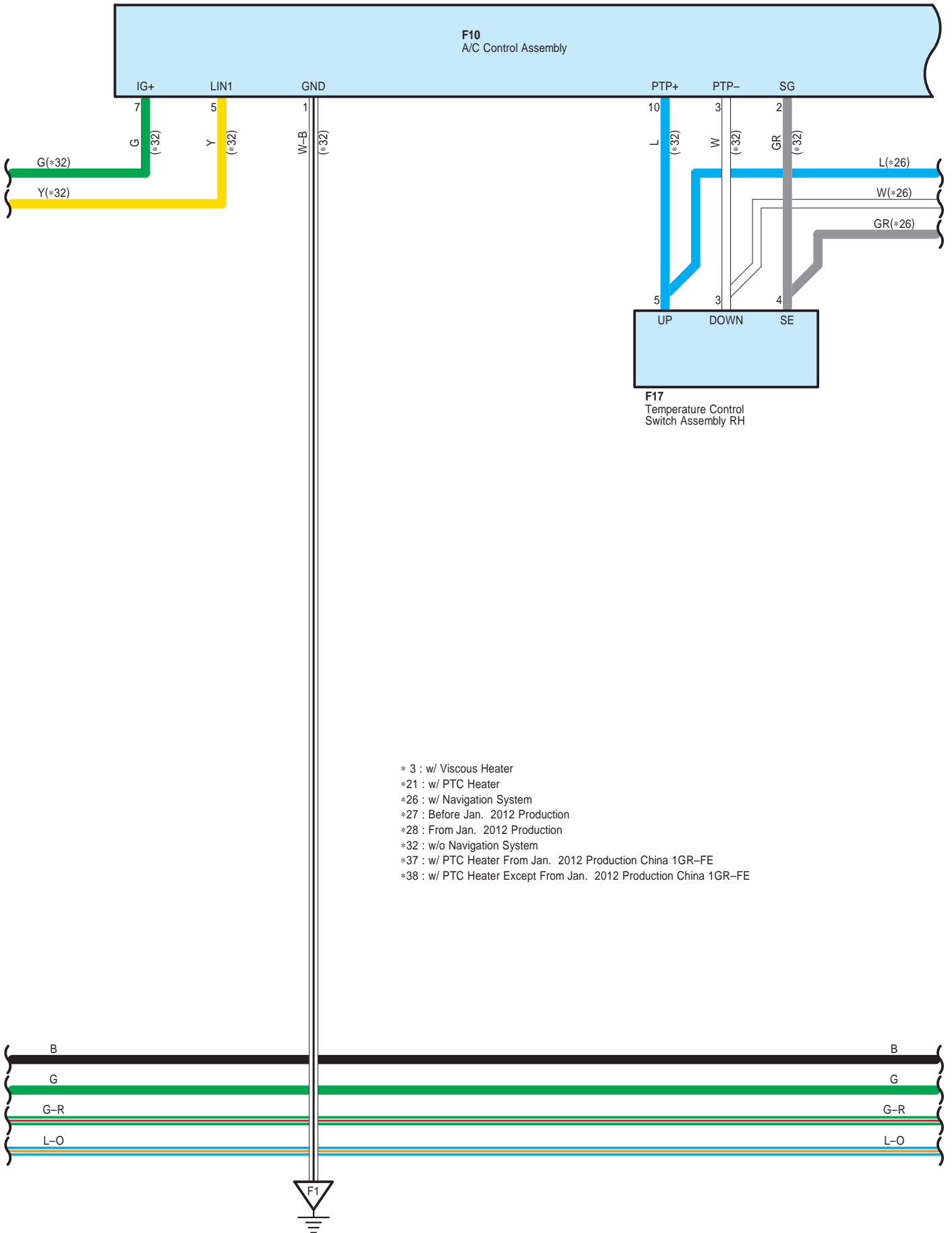

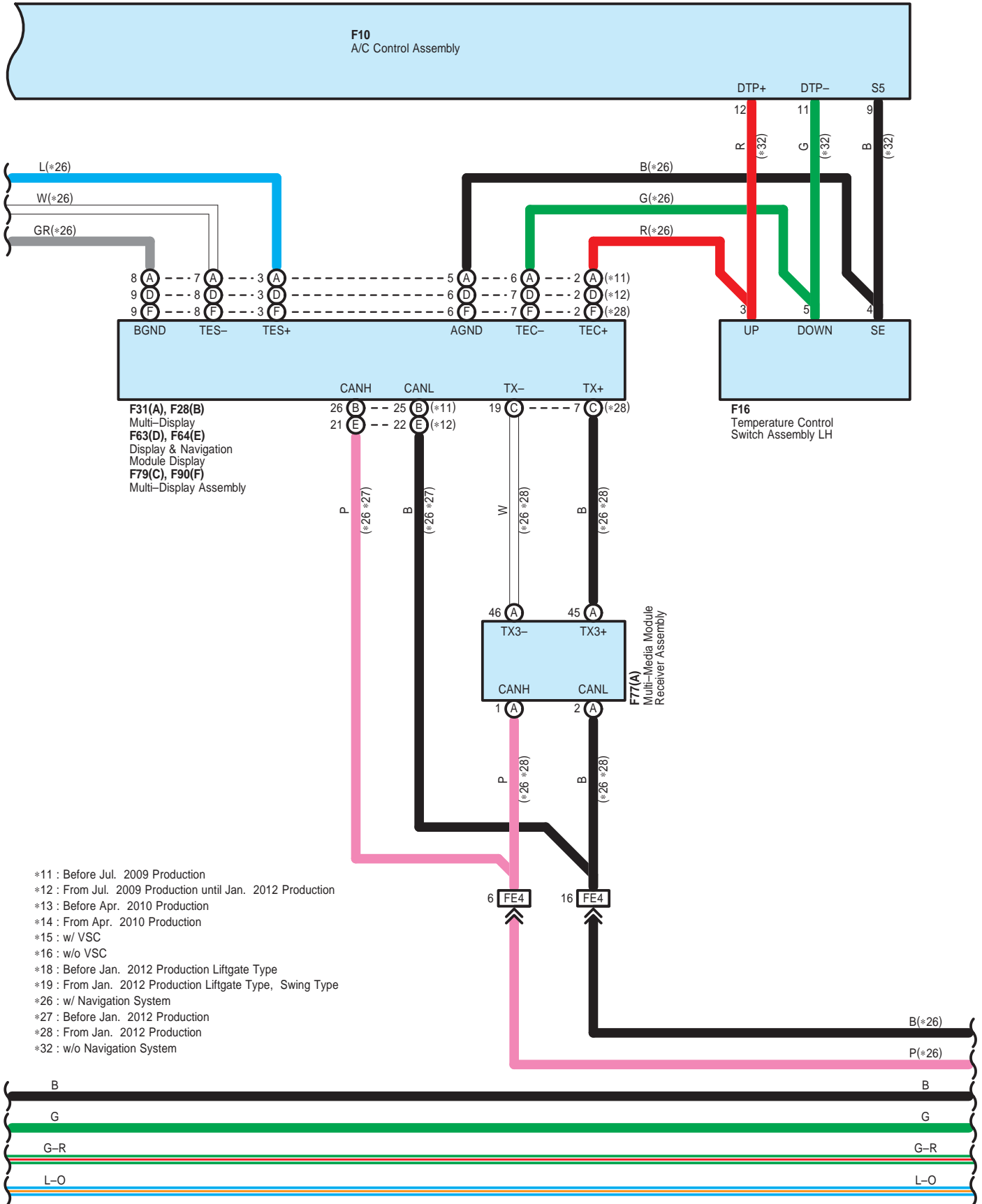

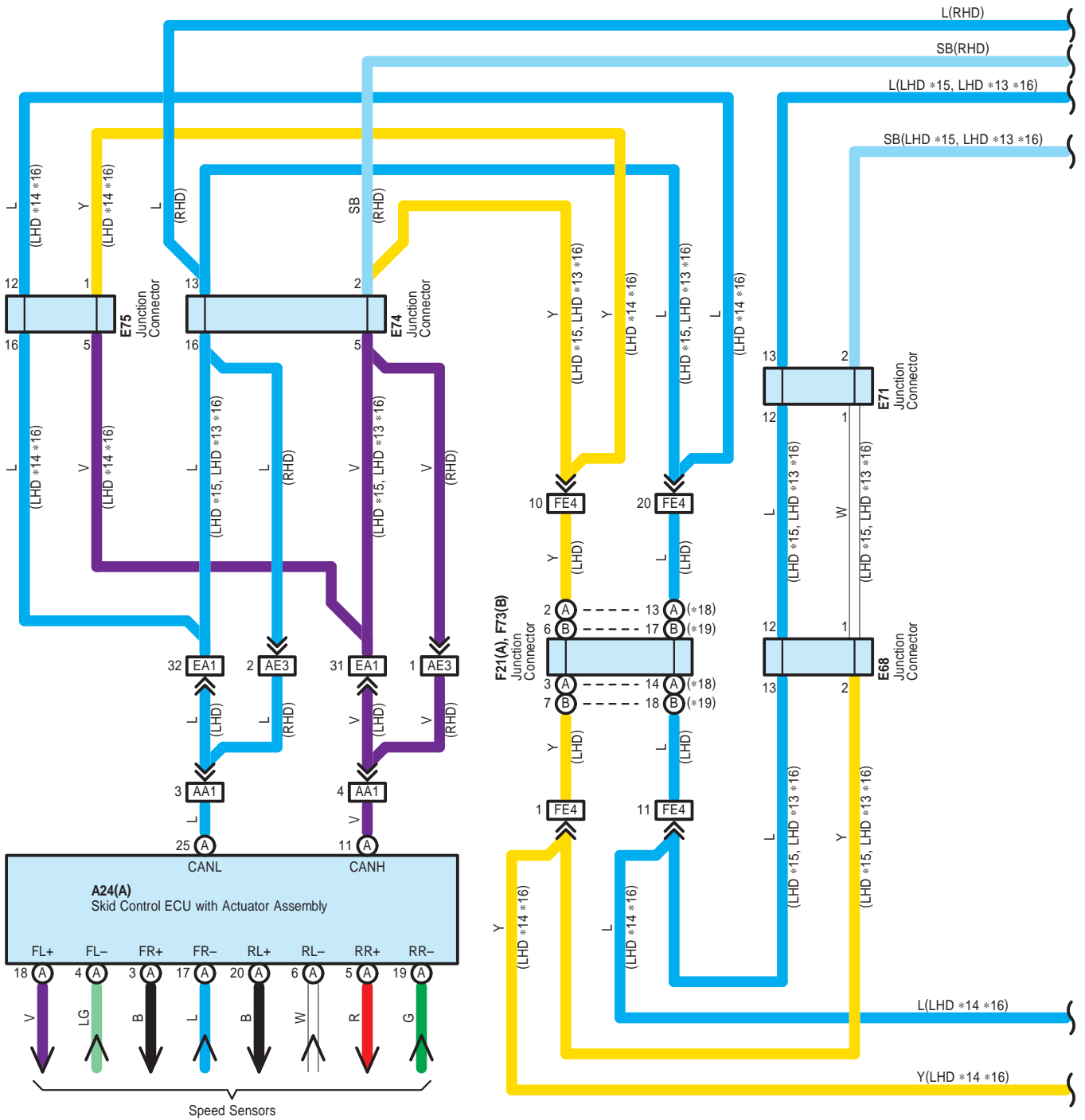

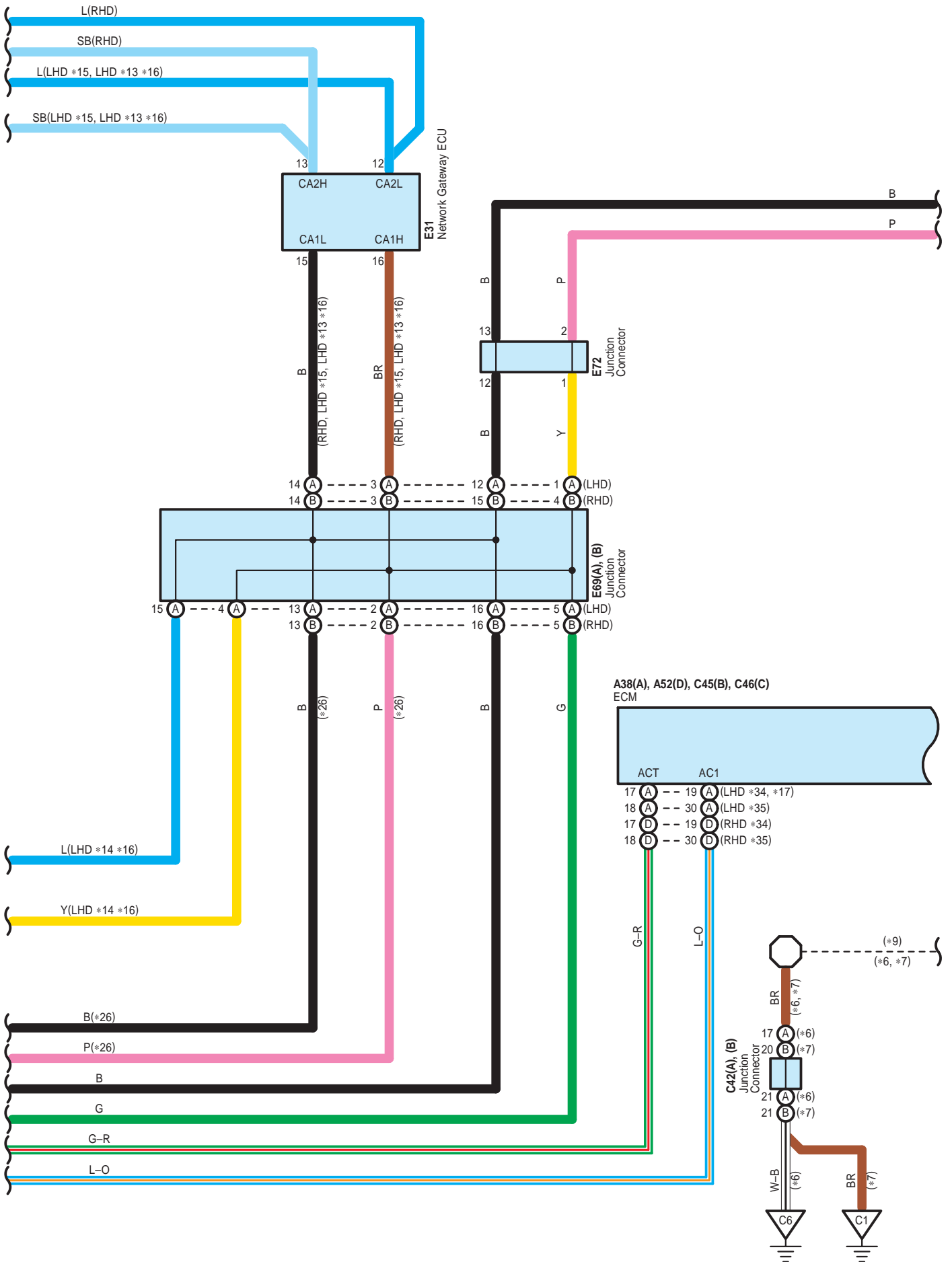

A 13
Black

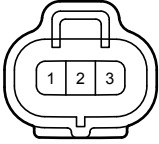

A 14
Black



A 24
Black

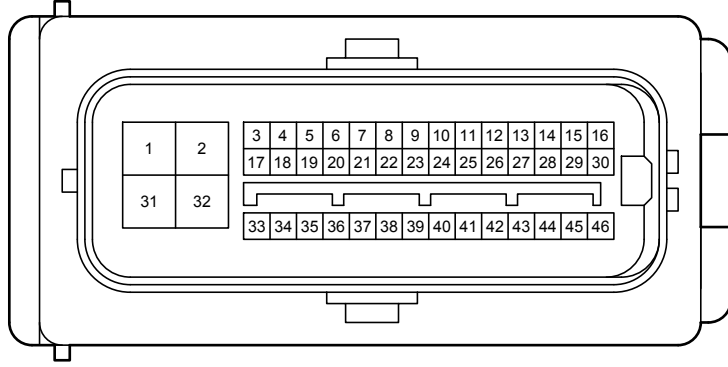

A 29
White

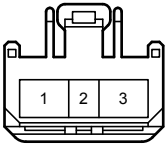

A 34
White

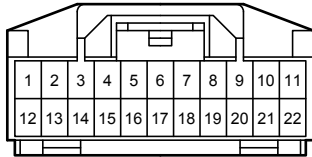

A 38
Black

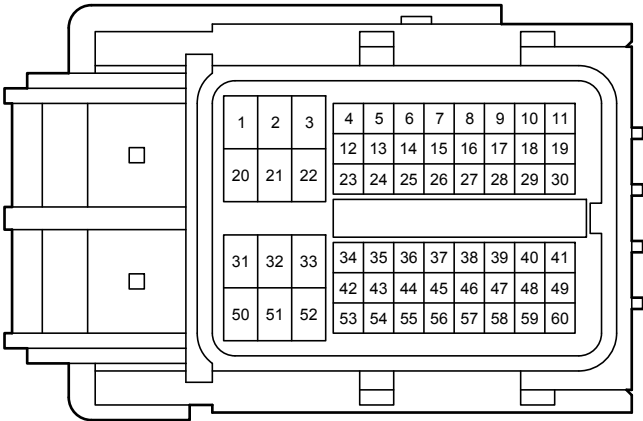

A 52
Black

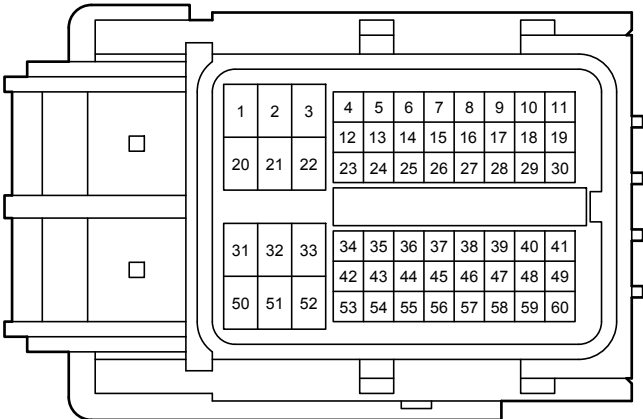

C 1
Black

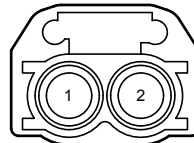

C 18
Dark Gray



C 30

Gray

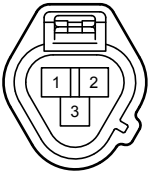

C 42

White

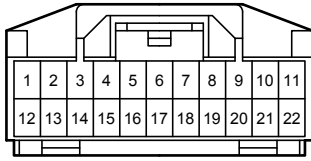

C 43

White

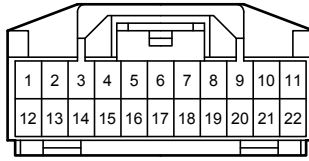

C 44

Blue

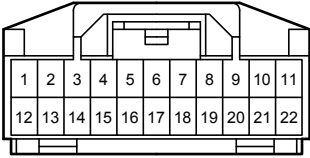

C 45

Black

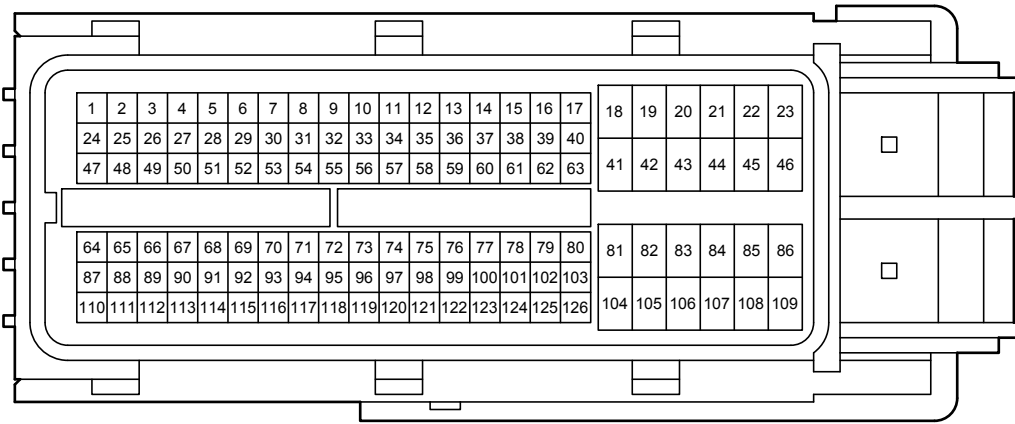

C 46

Black

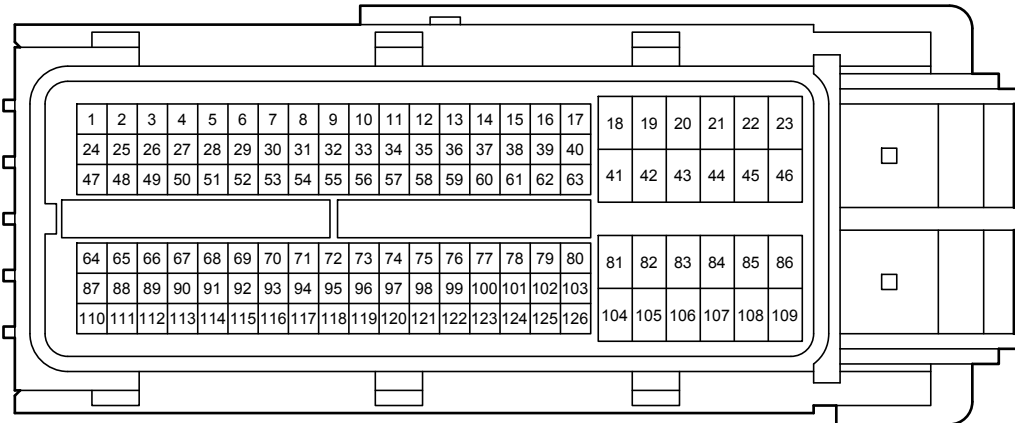

C 48

Dark Gray



C 65

Black

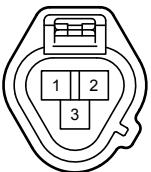

C 71

Gray



C 92

Black

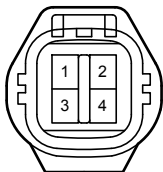

C 94

Gray

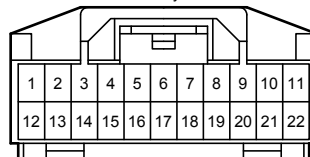

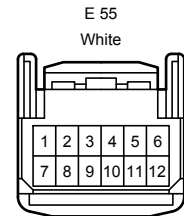
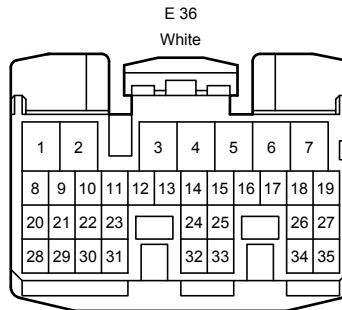
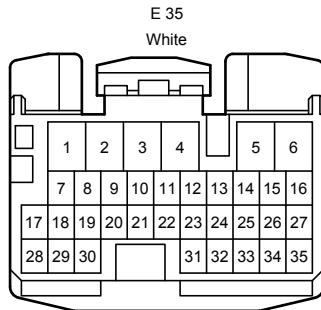
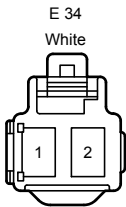
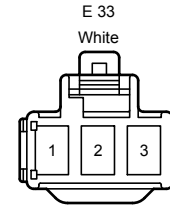
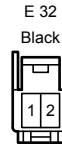
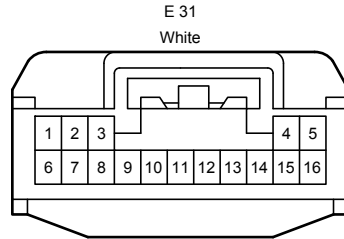
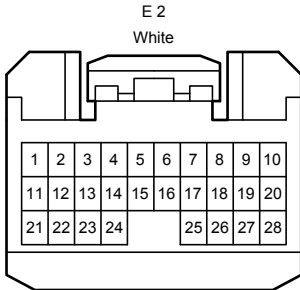
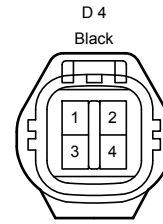
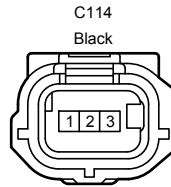
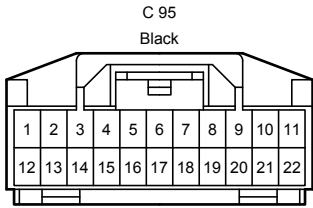

E 58

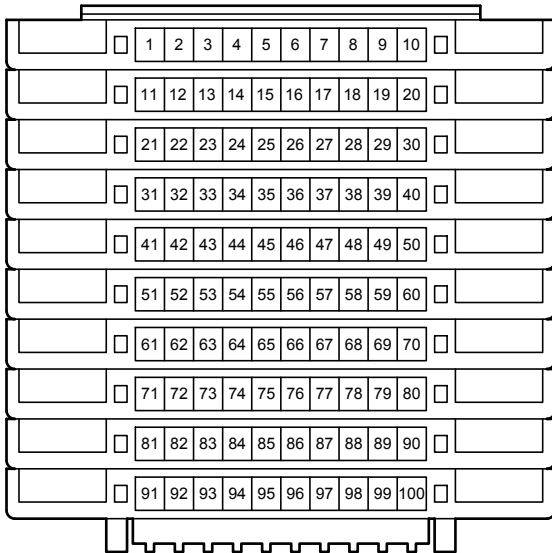

E 59

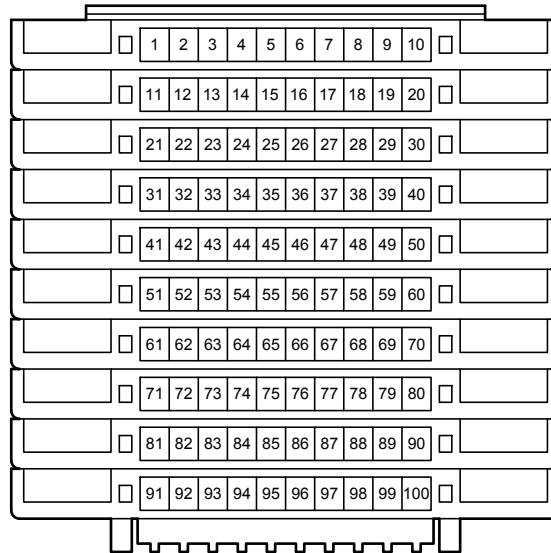

E 60

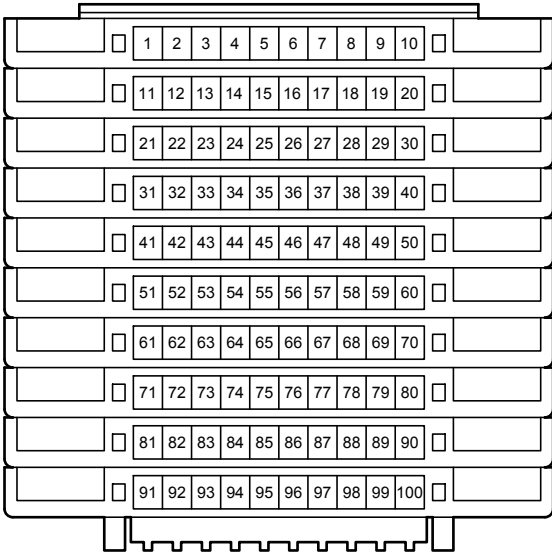

E 62

White

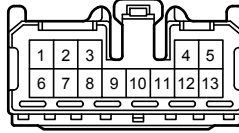

E 66

White

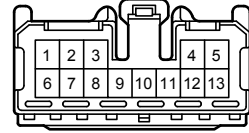

E 68

Gray

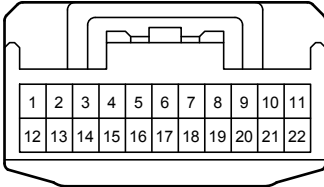

E 69

Gray

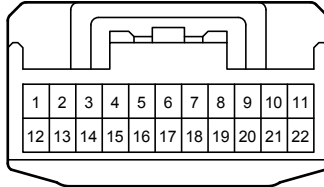

E 71

Gray

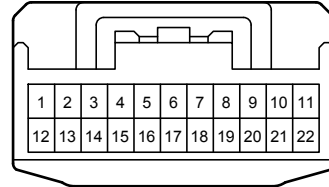

E 72

Gray

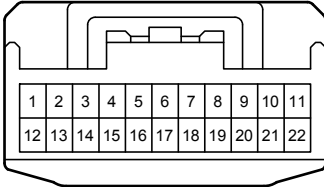

E 74

Gray

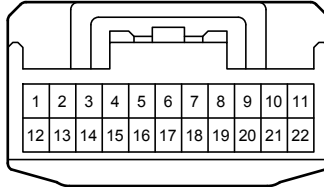

E 75

Gray

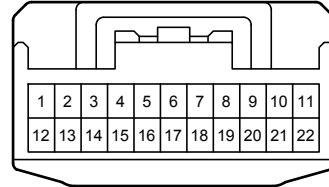

E 81

White

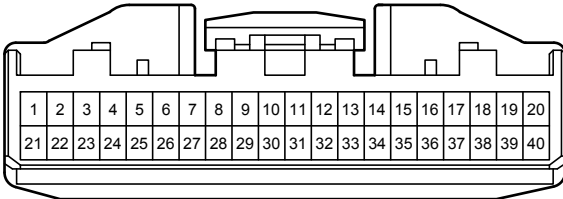

E 89

Black

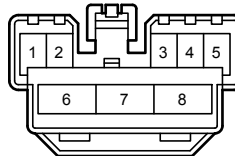

E 97

Black

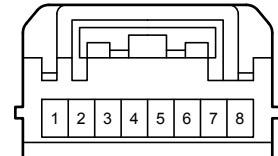

E 110

White

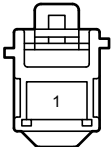

E 112

Black

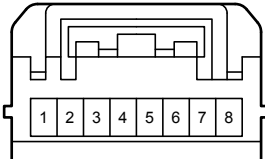

F 9

Black

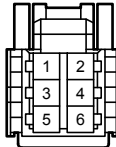

F 10

White

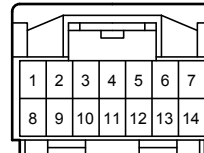

F 16

White

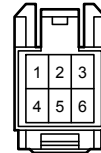

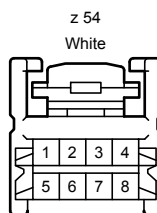
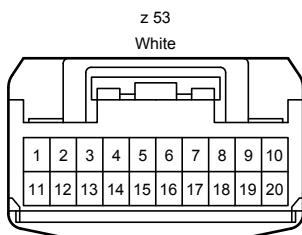
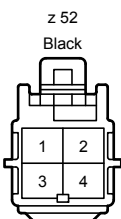
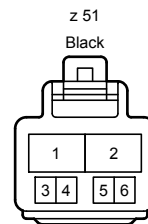
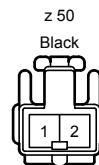
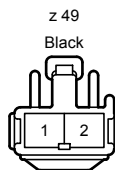
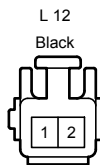
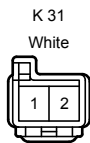
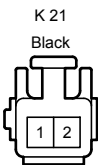
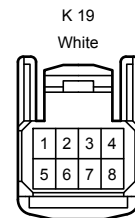
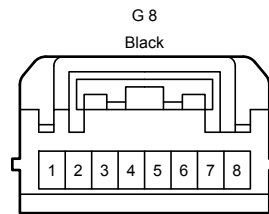
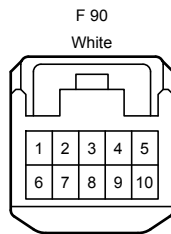
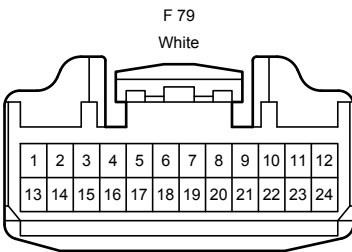
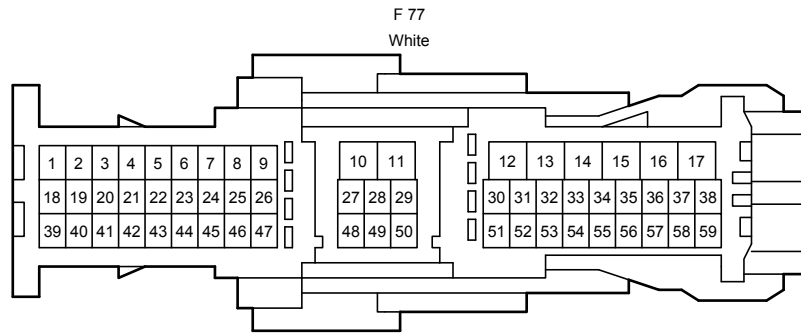
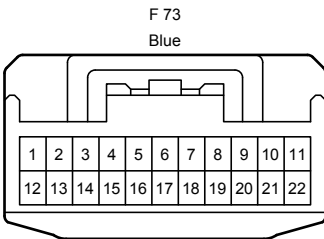
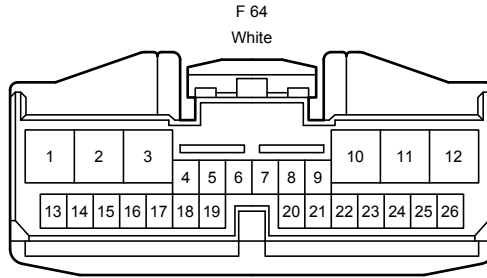
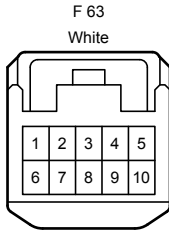
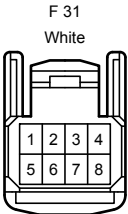
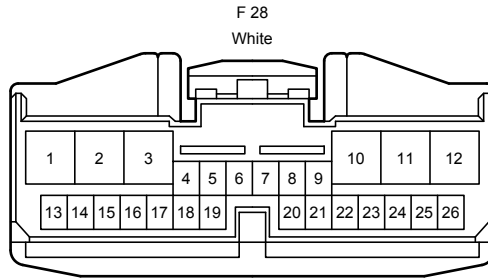
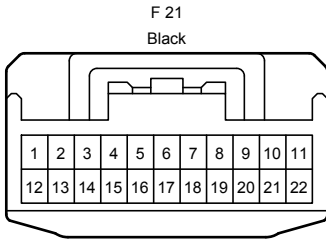
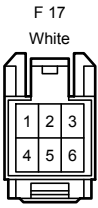

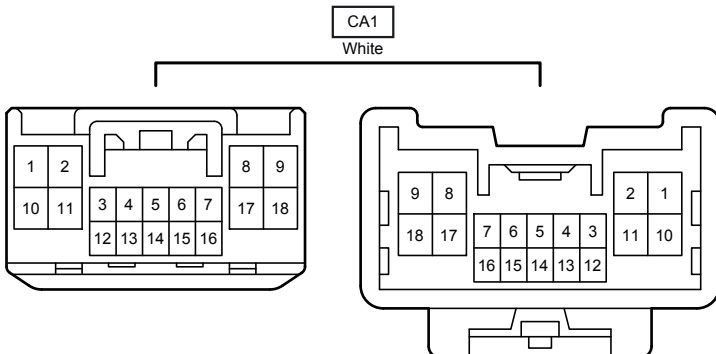
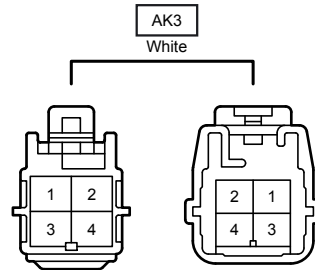
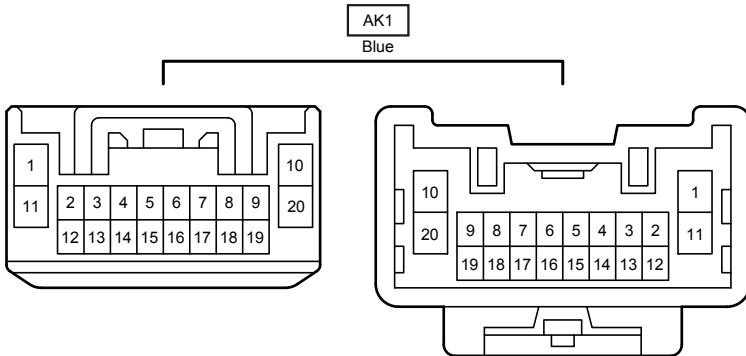
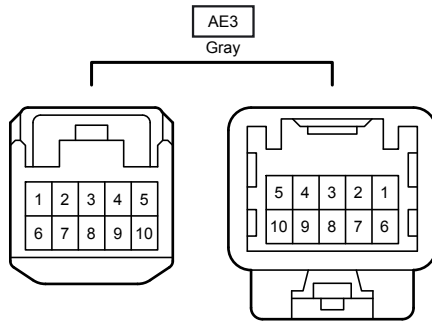
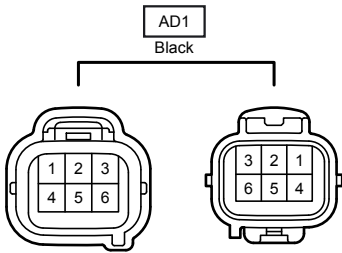
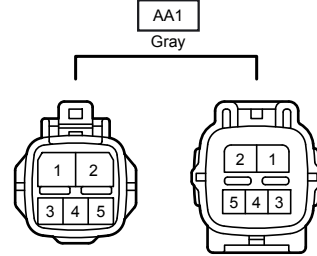
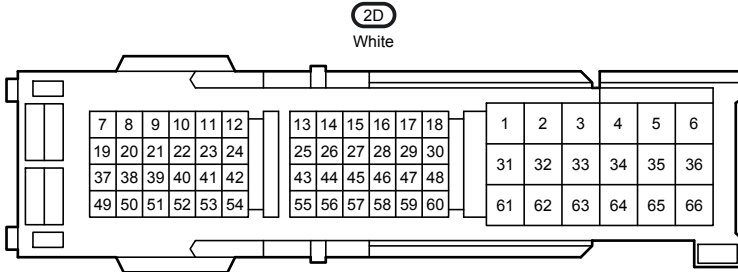
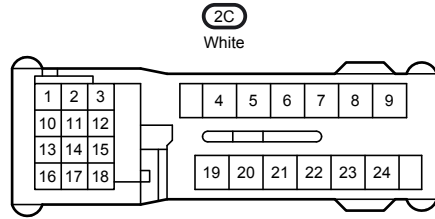
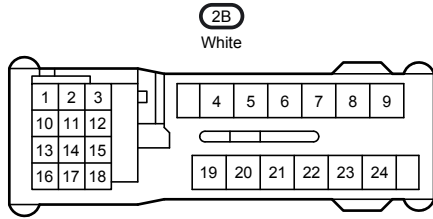
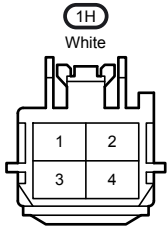

CA2
White

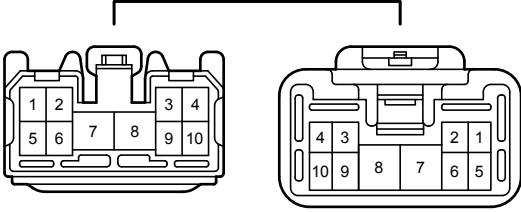

CA4
White

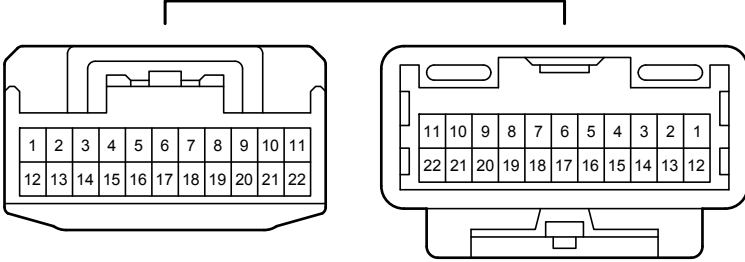

EA1
White

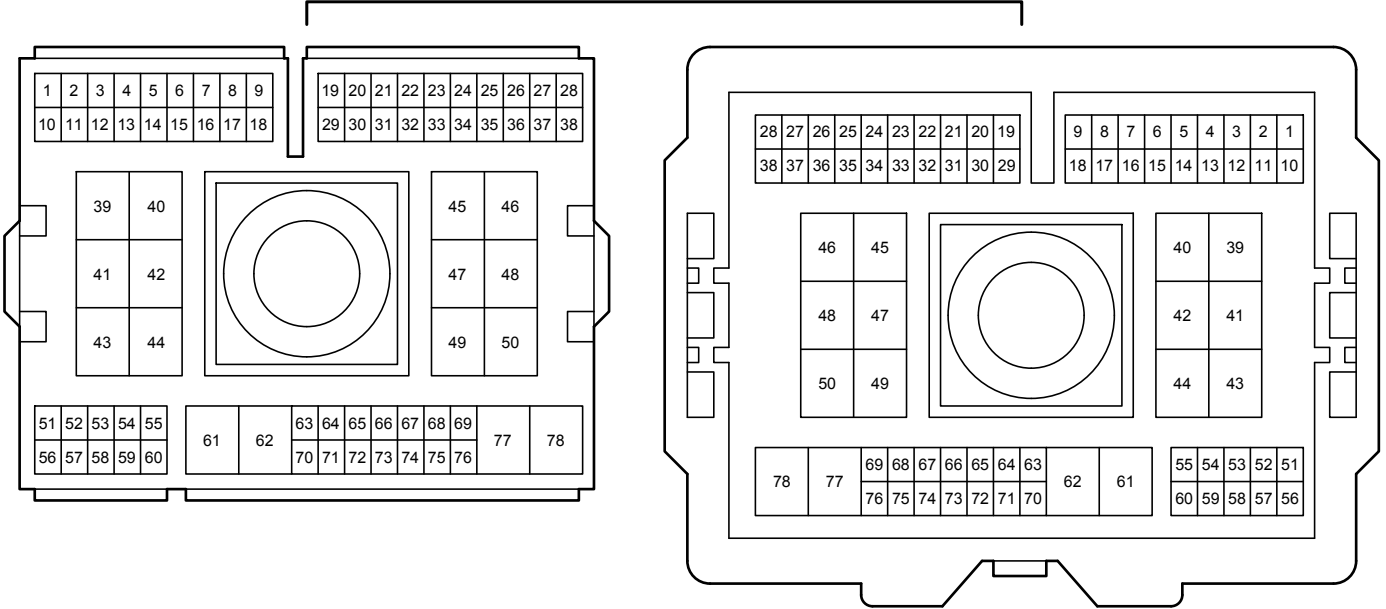

EA2

White

Gray

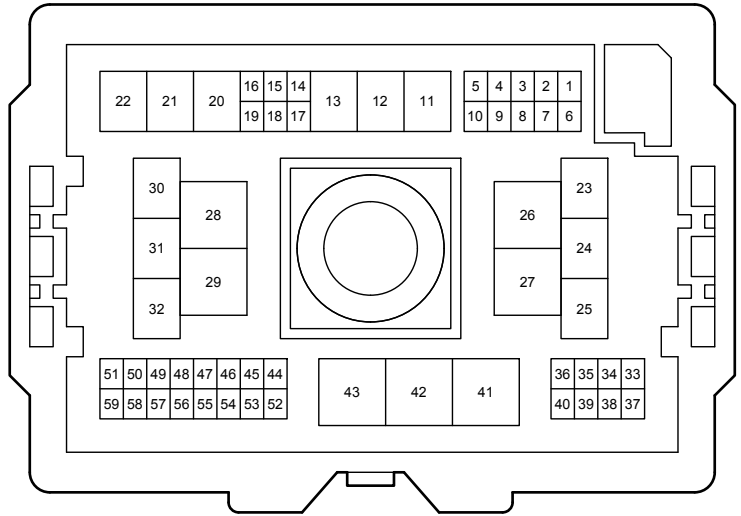
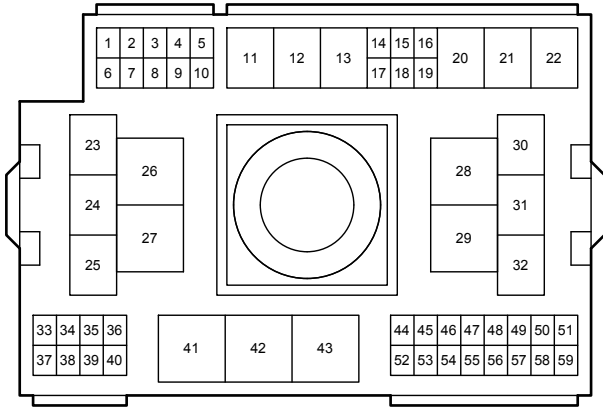

EA3

White

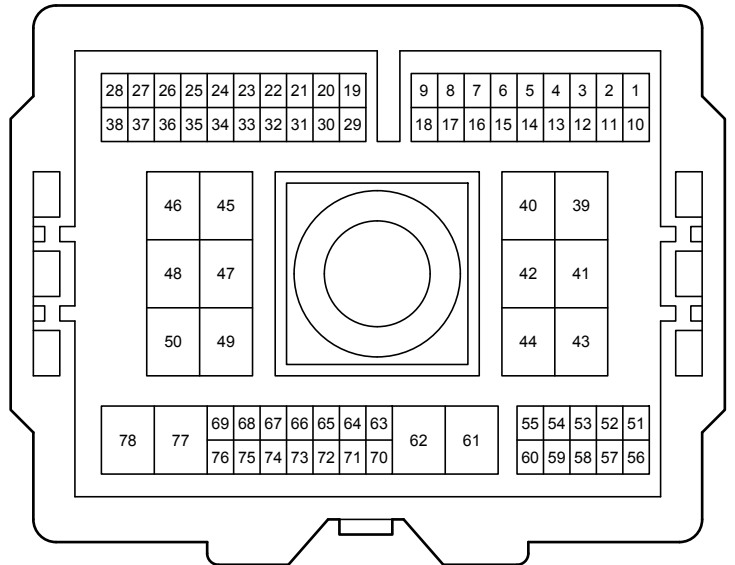
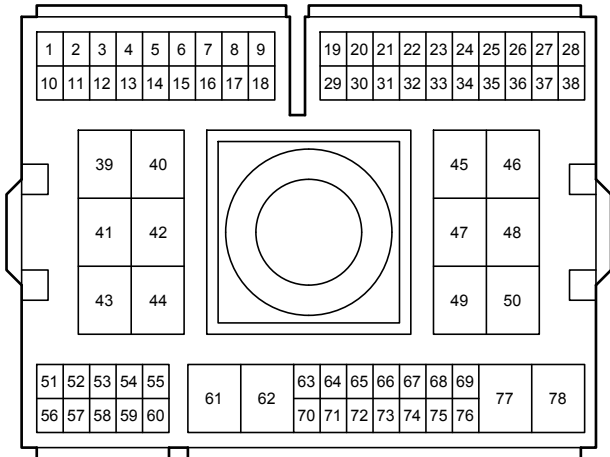

EK1

White Blue

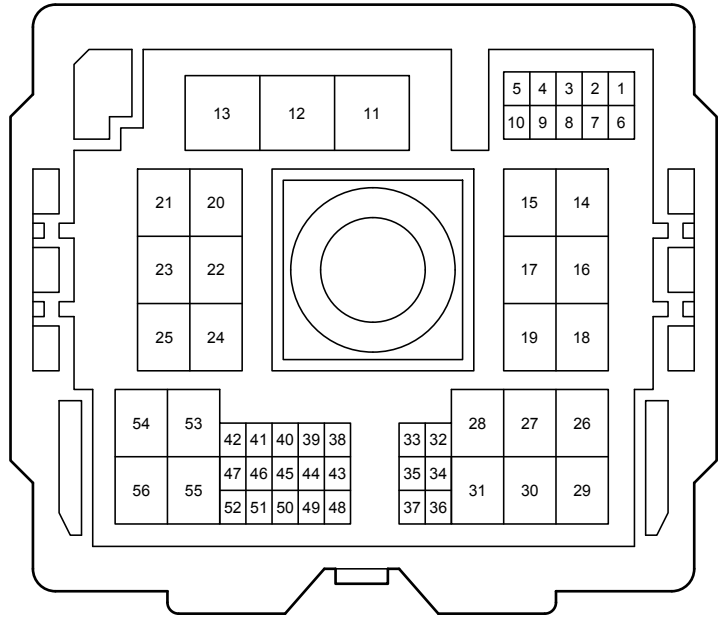
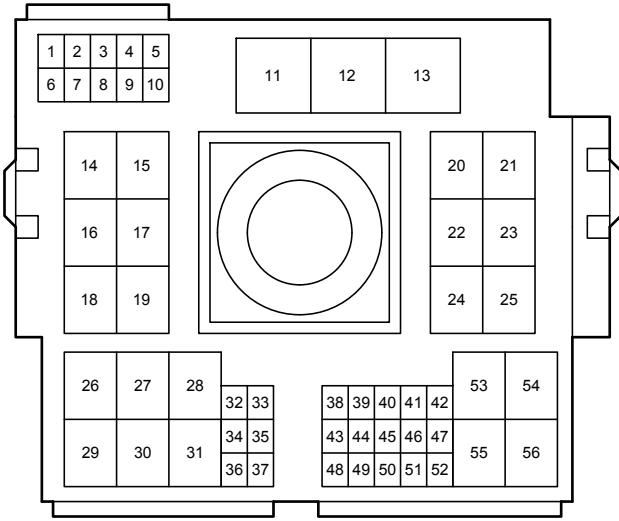

EK2

White

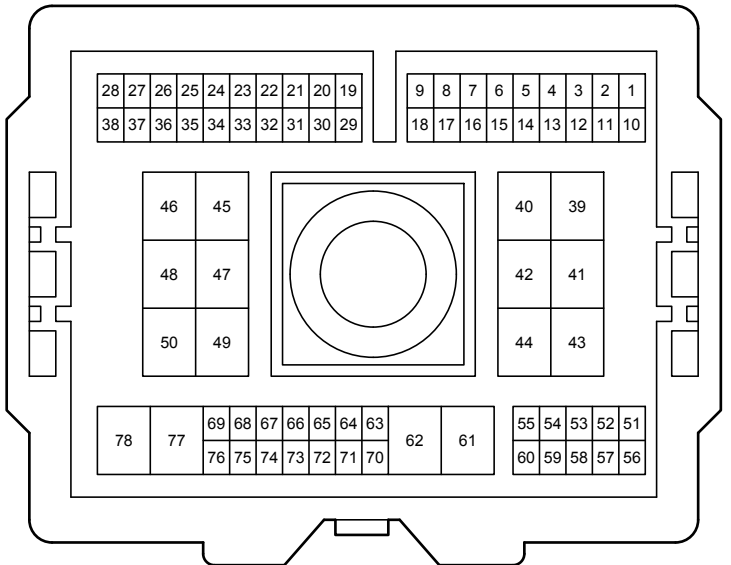
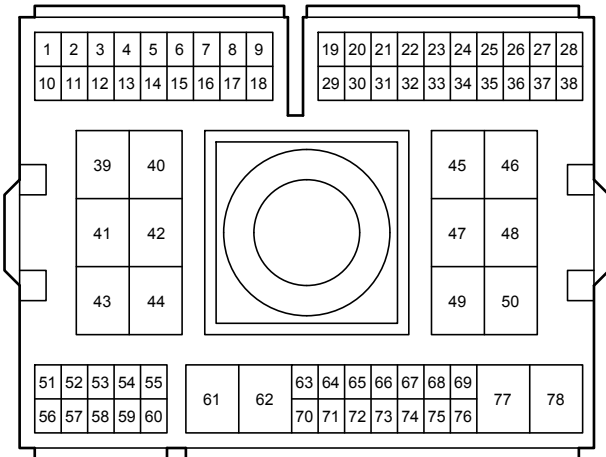

EL1
White

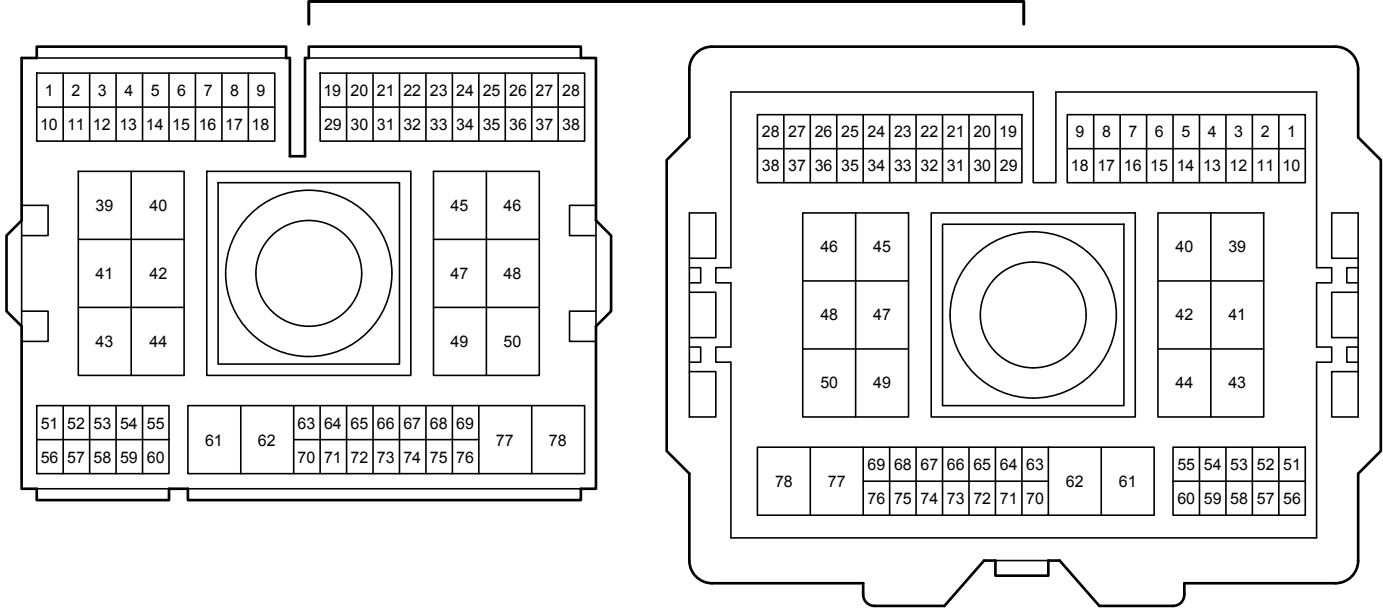

FE4
White

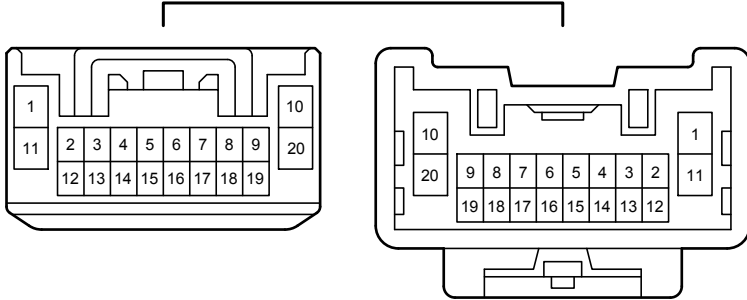

FE6
White

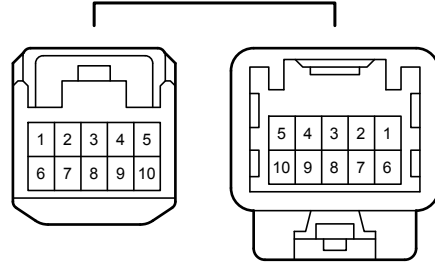

GE2
White

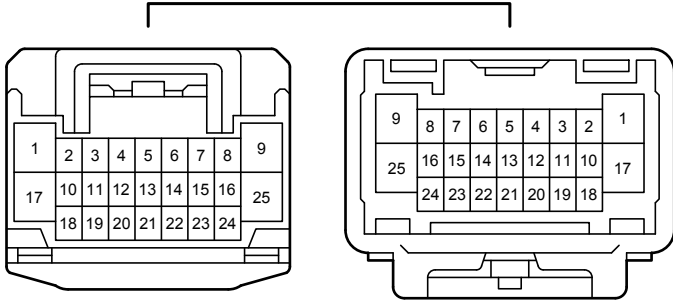

Kz1
Blue

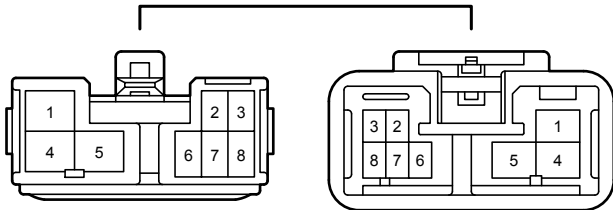

Kz2
White

